



S SERIES

Read prior to assembly.
安装前请仔细阅读本说明书。
lire avant l' assemblage.
Lesen Sie die Anleitung vor
dem Zusammenbau.

Leer antes de ensamblar.
Leia antes de montar.
Прочитайте до начала сборки.
조립 전에 읽어 보시기 바랍니다.
アセンブリの前にお読みください。

All specifications and figures are subject to change without notice.
All trademarks and logos are the properties of their respective holders.



Table of Contents - English

English

What's Included

| | |
|------------------|---|
| Chair Components | 1 |
| Accessories | 2 |

Assembly Instructions

| | |
|-----------------------------------|-----|
| Chair Assembly | 3-6 |
| How to install the head cushion | 7 |
| How to install the lumbar support | 8 |

Detailed Dimensions

| | |
|--------------------|---|
| Dimensions Diagram | 9 |
|--------------------|---|

Care & Use Instructions

| | |
|-------------------------|----|
| Care & Use Instructions | 10 |
|-------------------------|----|

Shift Series

Basic installation and operation instructions for Clutch Brand S-Series chairs. Copywrite 2016©.
For more detailed instructions, including assembling videos, visit www.clutchchairs.com/assembly_instructions.

What's Included - Chair Components

Please ensure that all of the components listed below are included in the package.
Contact your local reseller if anything is not included.



Backrest x 1

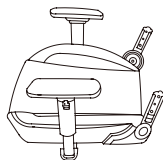

Seat Pan x 1

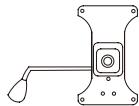

Mechanism x 1



Gas lift & Cover x 1

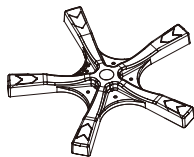

Chair Base x 1



Castor x 5



Side Cover x 1



Side Covers x 1



Chevron Insert x 5



M8 Allen Key x 1

What's Included - Accessories



Head Cushion x 1



Lumbar Support x 1

Please note: Use of the head cushion and lumbar support are optional.
Clutch Chairs Ltd recommends using them for 2-3 days before deciding whether you prefer to use each item or not.

Note: Required M8 bolts are already installed in their corresponding sockets.
i.e. - 4 bolts in the backrest and 4 bolts in the underside of the seat pan.

Assembly Instructions - Chair Assembly

1. Place the base upside down on a firm but padded surface. We recommend placing a piece of foam from the box on the floor. Firmly insert the 5 castors into the corresponding holes.

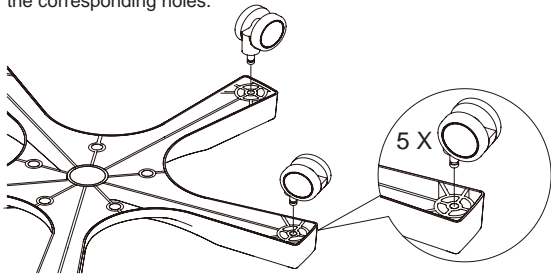

2. Turn the base right side up and insert the colour accent chevrons in the end of each arm of the base.

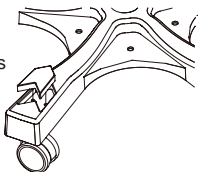

4. Insert the thick end of the gas lift into the center hole of the base and slide the plastic cover into place.

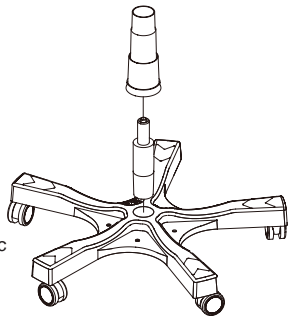

3. Insert the faux bolts into the holes in the center hub of the base.

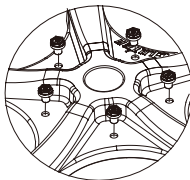

Assembly Instructions - Chair Assembly

4. Remove the 4 M8 bolts that are already installed on each side of the backrest. Then position the backrest between the hinges that are attached to the seat pan. Reinstall the 4 M8 bolts into their original holes once the hinges are in place. Be sure to use your fingers to start the bolts and be careful to ensure they are not cross threaded. Proceed by firmly tightening the bolts with the allen key provided.

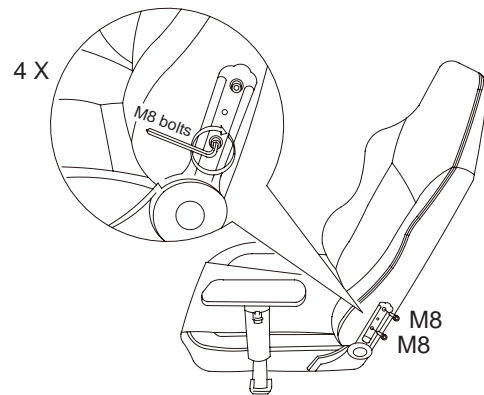
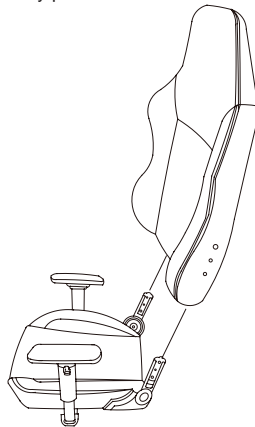

Assembly Instructions - Chair Assembly

5. Install the plastic side covers using the Phillips screw driver head on the allen key provided. Be sure not to over tighten as you may crack the plastic cover.

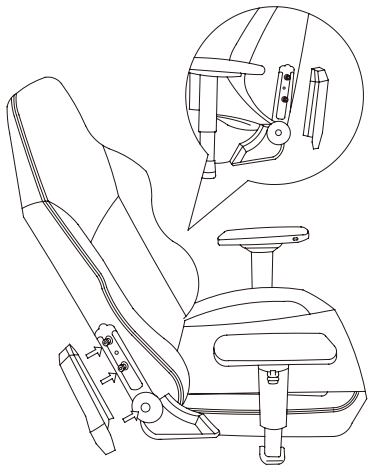

6. Remove the 4 M8 bolts already installed on the underside of the seat pan. Position the mechanism to align with those same holes and reinstall the bolts. Again, be sure to start the bolts using your fingers to ensure they are not cross threaded. Proceed by firmly tightening the bolts with the allen key provided.

4 X M8

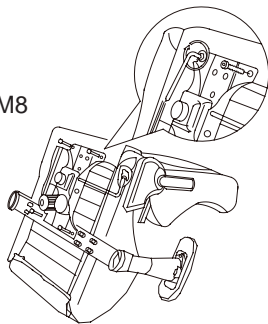

Important Note: Ensure that the mechanism is orientated correctly, front to back, as per the diagram above.

Assembly Instructions - Chair Assembly

7. Connect the upper portion of the chair to the base by inserting the gas lift into the corresponding hole in the mechanism. Keep the upper part of the chair as vertical as possible to ensure the gas lift seats properly into the mechanism.

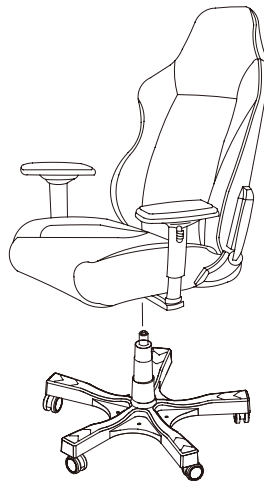

Congratulations!
You've just completed
assembly of your new
Clutch Chair.



Assembly Instructions - How to install the Head Cushion

Place the straps completing around the upper portion of the backrest and secure them with the side release plastic buckle.

Then tighten the strap to hold the head cushion in the desired position.
Neatly roll/fold the excess strap to about 2 inches wide and tuck it under the black rubber band.

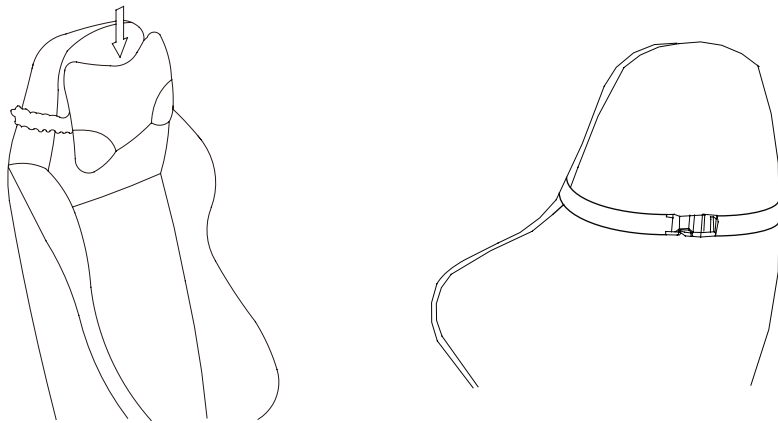

Assembly Instructions - How to install the Lumbar Support

The lumbar cushion is designed to rest on the seatpan, it does not physically attach to the chair. The size and ergonomic design create the perfect support for your lumbar spine. If you prefer the cushion to sit a little higher on your back you can manually move it up while you are in a seated position. Simply sit as you normally would then lean forward slightly, position the lumbar cushion exactly where you want it then lean back and sit normally.

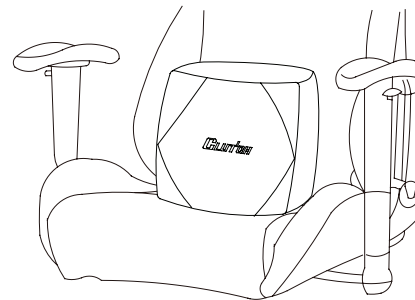

Detailed Dimensions - Dimension Diagram

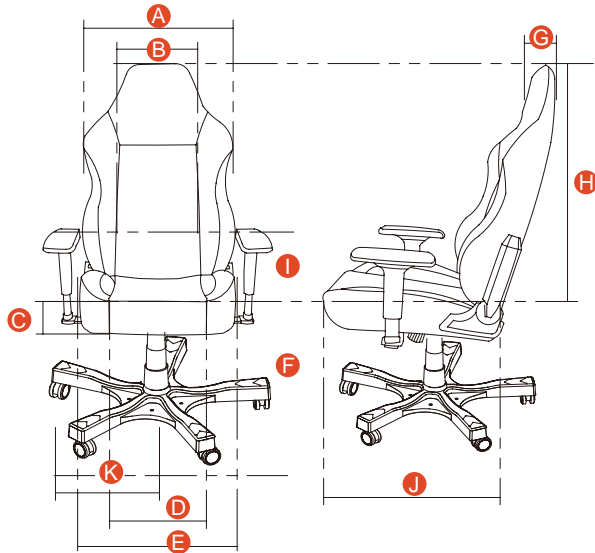

- A 550
- B 280
- C 80-100
- D 330-380
- E 530
- F 320-400
- G 100
- H 740
- I 290-380
- J 570
- K 350

Units - mm

Care & Use Instructions

How to get the most out of your new Clutch Chair

1. Keep out of direct sunlight. Long term exposure to UV rays will fade and weaken the upholstery.
2. When moving the chair be careful not to collide with surrounding objects.
3. Sit only on the seat pan to avoid risk of tipping the chair. Exercise extra caution when the chair is reclined.
4. Do not use excessive force when operating the height and tilt control levers. Only light to medium pressure should be required.
5. Do not apply excessive force of weight to the armrest.
6. Do not exceed the chairs recommended weight limit.

Cleaning Instructions

Regular cleaning with a slightly damp microfiber cloth or terrycloth rag will keep your chair looking good for years to come. Do not use any harsh chemicals or cleaners. Immediately wipe off any liquids or foods that may be spilled on the chair.

A mild foam upholstery cleaner is recommended for stain removal on fabric chairs. Be sure to test any cleaner on an inconspicuous portion of the chair first.



Pinch Point Warning - Use caution when operating the lever that adjusts the angle of the backrest.